

# THE FIFTH ELEMENT

## USER INSTRUCTIONS

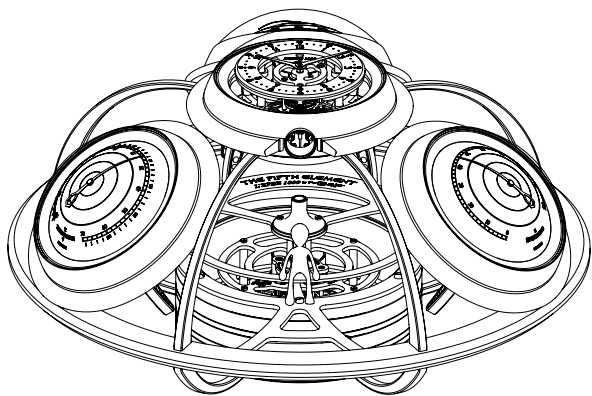

**MB&F** + *L'ÉPÉE* 1839



## **CONGRATULATIONS**

You have just acquired an advanced instrument born from a partnership between MB&F and L'Épée 1839.

The Fifth Element has been developed with passion and care by L'Épée 1839 in Delémont - Switzerland.



# CONTENTS

Care and maintenance	6
The structure	8
Clock	10
Hygrometer	12
Thermometer	13
Barometer	14

## CARE AND MAINTENANCE

Fingerprints will damage the coating so always wear gloves when manipulating the structure and its elements – and wipe off any fingerprints immediately.

Use only a soft and dry cloth to clean the structure and its elements. Dust and particles contained in the cloth could scratch parts. Do not use any kind of cleaning products.

It is recommended to keep The Fifth Element distant from any source of heat or vibrations. To preserve the longevity and functionality of The Fifth Element, do not permanently expose the elements to direct sunlight, a blower, or in a humid or dusty place.

Our instruments are developed to ensure optimal accuracy and reliability. It is well accepted for a fine mechanical clock to have a few seconds' variation per day and our clocks are set so as not to delay. However if you should notice a bigger variation, please contact an authorized dealer who will advise you, or a L'Épée 1839 technical support center which will proceed with the necessary adjustment.

As for all Horological pieces of art, it is recommended to periodically service your clock. A mechanical masterpiece requires fine oils for the lubrication of the movement. These oils deteriorate over the years. We therefore advise having the movement serviced every 5 years. Be aware that the optimal period between servicing times can vary depending on the surrounding environmental conditions.

## CARE AND MAINTENANCE

The Fifth Element is composed of:

- 4 elements (clock, hygrometer, thermometer, barometer)
- 1 main structure with 4 landing stations for the elements
- 1 key

It is recommended not to put pressure or tension on the main structure. The best way to handle the structure is to manipulate it by the biggest ring, having previously removed the 4 elements before (each element is approx. 2 kg).

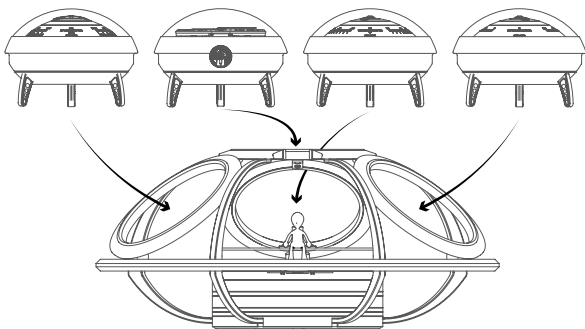

## THE STRUCTURE

The Alien and its ring rotate thanks to a mechanical movement placed in the center of the main structure. Only the Alien and ring move, not the entire structure. They turn in the clockwise direction.

The position of the ring and Alien can also be adjusted by hand in order to reposition the Alien when the rotation stops. However, always turn in the clockwise direction; be aware that turning the alien and ring anti-clockwise could break the movement.

Wind the movement with the integrated key placed in the middle of the structure. Similarly to winding a mechanical clock movement, you will feel the resistance steadily increase when winding the movement; do not force excessively.

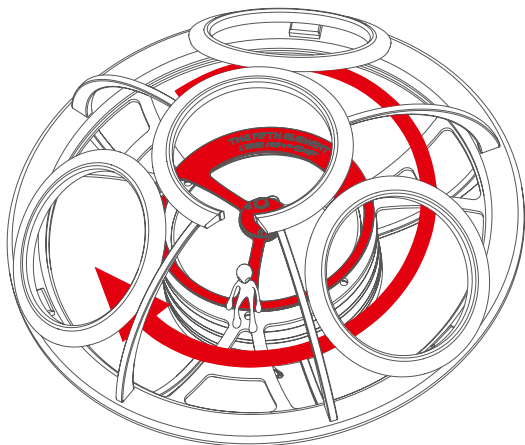



## THE STRUCTURE

### Start/stop function:

Once the movement is fully wound, a "start" button allows you to start the rotation of the Alien and its ring. Push horizontally on "start" to start the movement; it disappears under the main plate of the structure, to appear as "stop" on the opposite side. Do not push vertically. In the same way, push horizontally on "Stop" to stop the rotation.

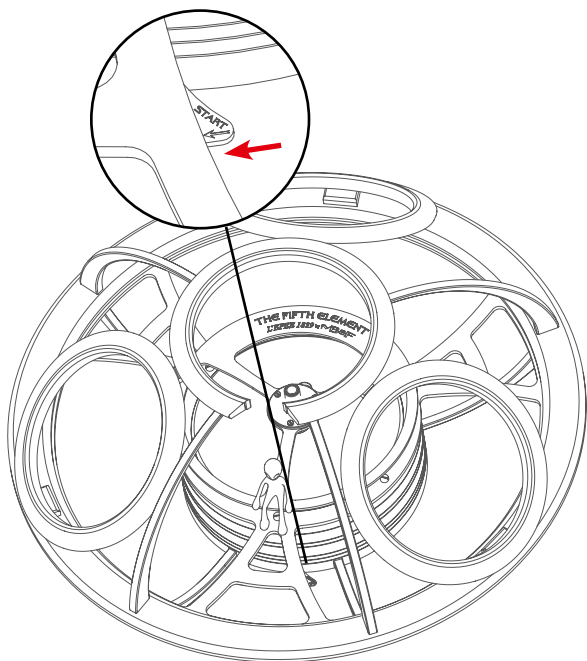

# CLOCK

## Reading the time

Hours and minutes are displayed under a glass dome on the clock element.

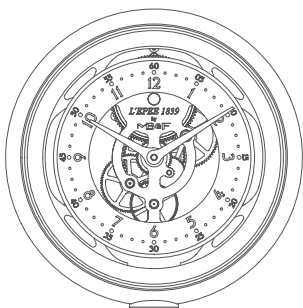

## Setting the time

Remove the element from its station, use the key and place it as displayed in the diagram. Turn only anti-clockwise (as indicated by the arrow on the clock).

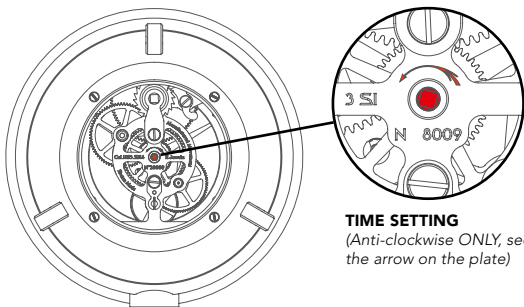

**TIME SETTING**  
(Anti-clockwise ONLY, see  
the arrow on the plate)

# CLOCK

## Winding the movement

Remove the element from its station, use the unique key and place it as displayed in the diagram.

The movement should be fully wound every 8 days. During the process, you will see the movement's wheels moving, allowing the barrel to be wound up. Be sure to wind the spring completely. Resistance will increase as you approach the full winding point, but continue to wind until you feel you have approached the breaking point (sign that the movement is fully wound). However, be very careful to stop before and do not force the mechanism by trying to go further than the breaking point.

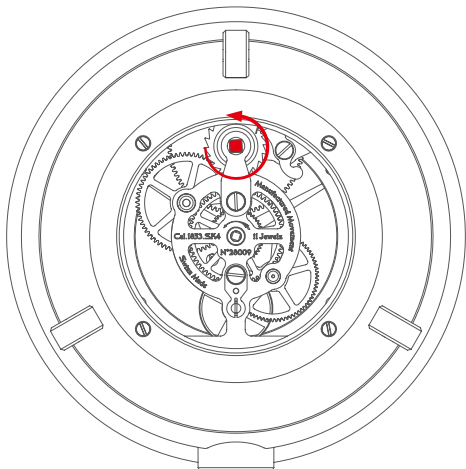

## HYGROMETER

The hygrometer indicates the relative humidity of the air where it is placed. This percentage varies considerably between outside air and indoor air, for example inside a house. A comfortable atmosphere corresponds to a rate of between 40 and 60% depending on the region.

One can check the correct operation of the instrument by comparing it to an electronic hygrometer. If there is a significant difference, it can be adjusted by acting on the adjustment screw accessible on the back of the element.

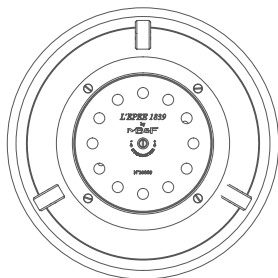
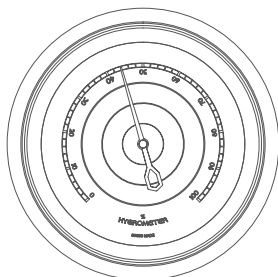

# THERMOMETER

Reading the temperature is possible in degrees Celsius (central graduation) and Fahrenheit (graduation outside the circle).

If you notice a significant difference between the indication of the thermometer and the actual temperature, the instrument can be adjusted by acting on the adjustment screw on the back of the element.

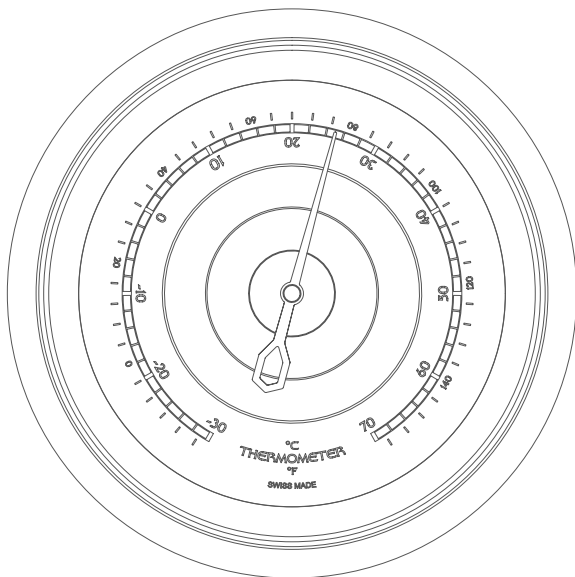

# BAROMETER

The barometer is used to measure atmospheric pressure, either in hPa (Hectopascal) or InHg (inches of mercury); and therefore an indication of the weather: "Rain/Change/Fair"

The barometer hand indicates the atmospheric pressure.

The hand will generally not reach the extremes; classic variations are usually between 1000 and 1025 hPa.

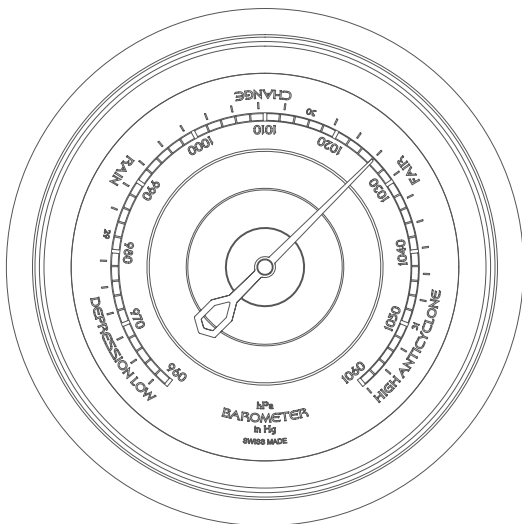

## BAROMETER

### Adjustment of the barometer:

When leaving our workshop, the instrument is set on the altitude of Delémont, Switzerland, about 435m above sea level. Adjustments can be done by using the adjustment screw on the back of the instrument. Turn the screw with a screwdriver so that the hand moves. The precise local adjustment can be made by comparison with a reference barometer (data available on the internet, nearest weather station or electronic barometer).

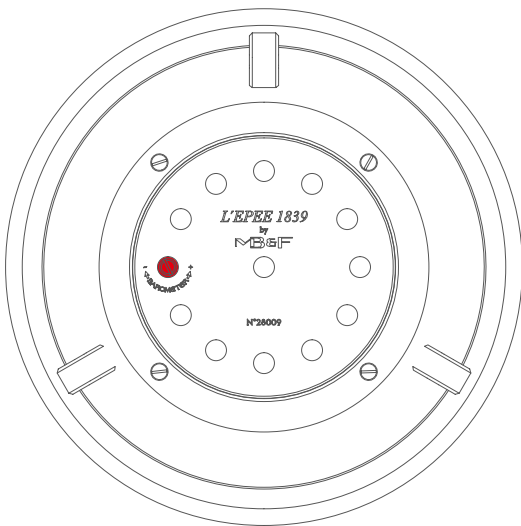

## **L'Épée Manufacture**

Rue St-Maurice 1 - P.O. Box 973  
2800 Delémont - Switzerland  
Tel. +41 (0)32 421 94 00

After Sales Services:  
Tel. +41 (0)32 421 94 05

[www.lepee1839.ch](http://www.lepee1839.ch)